

HI63

- Ensure the energy coordination between the arresters type T1 and T2 or the arresters type T2 and T3, especially in the places where there is no adequate distance between the arresters.
- If the energy coordination of surge protection is not observed, the excessive energy of passing impulse may cause a damage to the subsequent stage of the protective cascade.
- If there is at least 5 m distance between two successive arrester types (in case of two successive arrester types in two different switchboards), it is possible to omit the decoupling element.

Type		HI63
Rated operating AC voltage	U_N	500 V
Rated load current	I_L	63 A
Inductance $\pm 10\%$	L	6 μ H
DC resistance	R	< 0.01 Ω
Maximal back-up fuse		63 A gL/gG
Thermal class of insulation		A (105 °C)
Housing material		Polyamid PA6, UL94 V-0
Degree of protection		IP20
Operating temperature	θ	-40 ÷ 70 °C
Humidity range	RH	5 ÷ 95 %
Recommended cross-section of connected conductors	S	16 mm ²
Clamp fastening range (solid conductor)		2.5 ÷ 35 mm ²
Clamp fastening range (stranded conductor)		2.5 ÷ 25 mm ²
Tightening moment		3 Nm
Installation		On DIN rail 35 mm
Modular width		2 TE
Operating position		Any
Product placement environment		Internal
Remote signalling		No
Modular design		No
Designed according to standards		
Requirements and test methods for SPDs connected to low-voltage power systems		IEC 61643-11:2011
Safety of Flammability of Plastic Materials		UL 94
Application standards		
Protection against lightning		IEC 62305:2010
Selection and application principles for SPDs connected to low-voltage power systems		CLC/TS 61643-12:2009

Ordering, packaging and additional data

Mass	m	370 g
Mass (including the packaging)	m	384 g
Packaging dimensions (H x W x D)		45 x 102 x 74 mm
Packaging value	V	0.34 dm ³
ETIM group		EG000021
ETIM class		EC000613
Customs tariff no.		85363030
EAN code		8590681117132
Art. number		30 404



The link in the QR code leads to the online presentation of the HI63. There, in addition to the always up-to-date data sheet, you will also find all diagrams and drawings, declarations of conformity, or 2D or 3D models and other necessary materials. For more information, visit www.hakil.com



Application wiring diagram (installation)

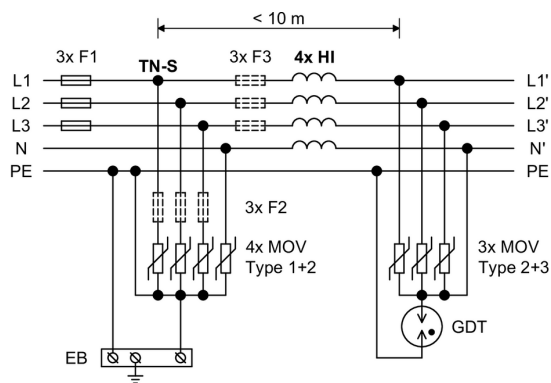

Internal diagram

